

ST 050 305 2979



Fits: IMO, LULU, TARA, LISSÉ, VAIA, META, CYO

- shower with fixed riser projection 453mm
- Rain shower: PURE RAIN, max. flow rate 7 l/min (at 3 bar)
- rain shower Ø 220 mm
- rain shower with anti-scale system
- Hand shower: COMPACT RAIN, max. flow rate 15 l/min (at 3 bar)
- spray head Ø 100mm
- rotary diverter with volume control and shut-off function
- slide-on rosettes Ø 70 mm
- height of fittings up to rain shower (bottom edge) 1009mm
- height of fittings up to top edge of elbow 1150mm
- gauge 150 mm - 13 mm
- metal shower hose 1750mm with integrated anti-twist protection
- 1/2" connection
- slide bar
- Pipe diameter 23.5 mm

| | | |
|--|--------------------------------|--------------------|
|  | Chrome | ST 050 305 2979-00 |
|  | Brushed Platinum | ST 050 305 2979-06 |
|  | Platinum | ST 050 305 2979-08 |
|  | Dark Chrome | ST 050 305 2979-19 |
|  | Brushed Durabronze (23kt Gold) | ST 050 305 2979-28 |
|  | Matte Black | ST 050 305 2979-33 |
|  | Brushed Champagne (22kt Gold) | ST 050 305 2979-46 |
|  | Champagne (22kt Gold) | ST 050 305 2979-47 |
|  | Brushed Dark Platinum | ST 050 305 2979-99 |

Individual components of this set

You need the following components for this set



1x 28 015 979-00



1x 34 459 979-00



Showerpipe with shower thermostat - Chrome

IMO

ST 050 305 2979



























ST 050 305 2979



- COMPACT RAIN, max. flow rate 15 l/min (at 3 bar)
- with anti-scale system
- spray head Ø 100mm
- 1/2" connection

Intrinsic protection against back flow.

Fits: IMO, LULU, MADISON, MEM, TARA,
CL.1, LISSÉ, VAIA, META, CYO

| | | |
|--|-------------------------------------|--------------------|
|  | Chrome | 28 015 979-00 |
|  | Chrome | 28 015 979-00 0010 |
|  | Brushed Platinum | 28 015 979-06 |
|  | Brushed Platinum | 28 015 979-06 0010 |
|  | Platinum | 28 015 979-08 |
|  | Platinum | 28 015 979-08 0010 |
|  | Dark Chrome | 28 015 979-19 |
|  | Dark Chrome | 28 015 979-19 0010 |
|  | Light Gold | 28 015 979-26 0010 |
|  | Light Gold | 28 015 979-26 |
|  | Brushed Light Gold | 28 015 979-27 |
|  | Brushed Light Gold | 28 015 979-27 0010 |
|  | Brushed Durabronze (23kt Gold) | 28 015 979-28 |
|  | Brushed Durabronze (23kt Gold) | 28 015 979-28 0010 |
|  | Matte Black | 28 015 979-33 |
|  | Matte Black | 28 015 979-33 0010 |
|  | Brushed Bronze | 28 015 979-42 0010 |
|  | Brushed Bronze | 28 015 979-42 |
|  | Brushed Champagne (22kt Gold) | 28 015 979-46 0010 |
|  | Brushed Champagne (22kt Gold) | 28 015 979-46 |
|  | Champagne (22kt Gold) | 28 015 979-47 |
|  | Champagne (22kt Gold) | 28 015 979-47 0010 |
|  | Brushed Chrome | 28 015 979-93 |
|  | Brushed Chrome | 28 015 979-93 0010 |
|  | Brushed Dark Platinum | 28 015 979-99 |
|  | Brushed Dark Platinum | 28 015 979-99 0010 |

ST 050 305 2979

mm [inches]



Flow rate chart



Certificates

DVGW_DW-6517DN0129. WRAS_2009011. LGA_29981.



Spare parts list

| No. | Item Number | Name | Quantity used | Delivery time |
|-----|-----------------|-------|---------------|---------------|
| 1 | 09 23 01 039 90 | sieve | 1 | 2 |

ST 050 305 2979



Fits: IMO, LULU, TARA, LISSÉ, VAIA, META

- shower with fixed riser projection 453mm
- overhead shower: rain flow
- rain shower Ø 220 mm
- rain shower with anti-scale system
- max. rainshower flow 7 l/min
- rotary diverter with volume control and shut-off function
- slide-on rosettes Ø 70 mm
- height of fittings up to rain shower (bottom edge) 1009mm
- height of fittings up to top edge of elbow 1150mm
- gauge 150 mm - 13 mm
- metal shower hose 1750mm with integrated anti-twist protection
- 1/2" connection
- slide bar
- Pipe diameter 23.5 mm
- quick clearing
- This product can help a building meet the requirements of Green Building Rating Systems, e.g. LEED®, BREEAM®, DGNB

This article does not include a hand shower!
Intrinsic protection against back flow.

| | | |
|--|-------------------------------|---------------|
| | Chrome | 34 459 979-00 |
| | Brushed Platinum | 34 459 979-06 |
| | Platinum | 34 459 979-08 |
| | Dark Chrome | 34 459 979-19 |
| | Light Gold | 34 459 979-26 |
| | Brushed Light Gold | 34 459 979-27 |
| | Brushed Durabronz (23kt Gold) | 34 459 979-28 |
| | Matte Black | 34 459 979-33 |
| | Brushed Bronze | 34 459 979-42 |
| | Brushed Champagne (22kt Gold) | 34 459 979-46 |
| | Champagne (22kt Gold) | 34 459 979-47 |
| | Brushed Chrome | 34 459 979-93 |
| | Brushed Dark Platinum | 34 459 979-99 |

Required miscellaneous

| | | |
|--|-----------------------------|---------------|
| | Hand shower - Chrome | 28 016 979-00 |
|--|-----------------------------|---------------|

Required miscellaneous

| | | |
|--|--|-----------------------|
| | Hand shower FlowReduce - Chrome | 28 016 979-00 0010 |
|--|--|-----------------------|

Required miscellaneous

| | | |
|--|-----------------------------|---------------|
| | Hand shower - Chrome | 28 017 979-00 |
|--|-----------------------------|---------------|

Required miscellaneous

| | | |
|--|--|-----------------------|
| | Hand shower FlowReduce - Chrome | 28 018 979-00 0010 |
|--|--|-----------------------|

Required miscellaneous

| | | |
|--|-----------------------------|---------------|
| | Hand shower - Chrome | 28 012 979-00 |
|--|-----------------------------|---------------|

Required miscellaneous

| | | |
|--|--|-----------------------|
| | Hand shower FlowReduce - Chrome | 28 012 979-00 0010 |
|--|--|-----------------------|

Required miscellaneous

| | | |
|--|-----------------------------|---------------|
| | Hand shower - Chrome | 28 018 979-00 |
|--|-----------------------------|---------------|

ST 050 305 2979

mm [inches]
1:10

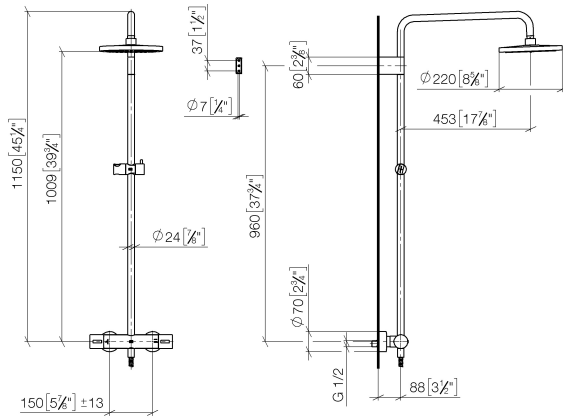

Flow rate chart

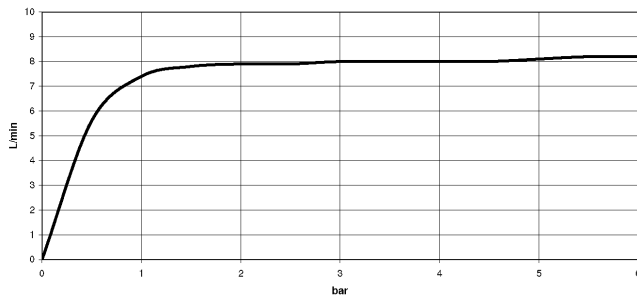

Certificates

DVGW_DW-
6509DN0123.

Belgaqua_21-032-
27_5.

WRAS_2204013.

LGA_38737.

ST 050 305 2979

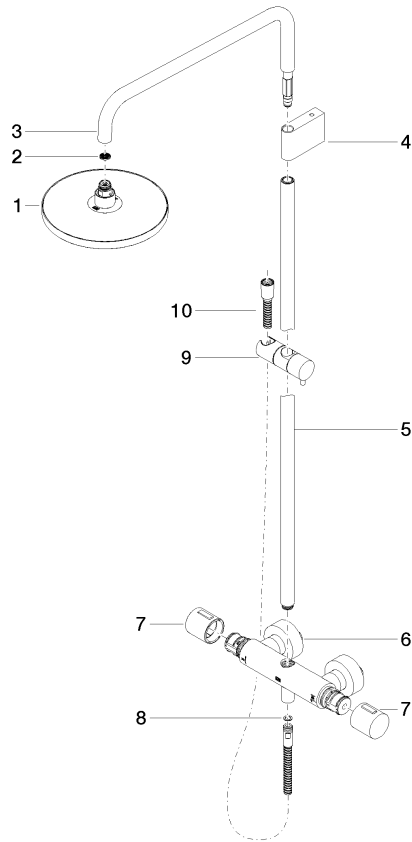

Spare parts list

| No. | Item Number | Name | Quantity used | Delivery time |
|-----|--------------------|--|---------------|---------------|
| 1 | 90 12 05 092 20-00 | shower | 1 | 10 |
| 2 | 09 23 01 039 90 | sieve | 1 | 2 |
| 3 | 90 28 22 348 00-00 | pipe | 1 | 10 |
| 4 | 90 17 11 150 00-00 | holder | 1 | 10 |
| 5 | 90 28 22 349 00-00 | pipe | 1 | 10 |
| 6 | 04 17 01 250 00-00 | connection | 1 | 10 |
| 7 | 90 17 33 015 00-00 | handle | 2 | 10 |
| 8 | 90 14 20 026 00 90 | seal | 1 | 2 |
| 9 | 12 570 970-00 | Slide unit - Chrome | 1 | 10 |
| 10 | 28 322 970-00 | Metal shower hose 1/2" x 3/8" x 1750 mm - Chrome | 1 | 2 |